

TECHNOLOGY TO INCREASE POWER OUTPUT OF A LOW-EMISSION/ HIGH-EFFICIENCY ENGINE

1.0

Engineers at Honda R&D Co., Ltd., Tochigi, Japan [Akimoto et al.], introduced technology employed for developing a two-liter, inline-four engine called F20C. The model F20C is the upscale version of the F20B which has been the powerplant of the Honda Accord™. The engine was uniquely designed to produce high specific power of 125 PS (93.2 kW) per liter considering the limited space requirement for the balanced weight distribution (50 percent front and 50 percent rear) of the S2000™ sports car. Cylinder bore was increased from 85 to 87 mm and the stroke was reduced from 88 to 84 mm. Because of the 2 mm increase of the bore, both the intake and exhaust valve diameter could be enlarged to increase the effective flow area by 15 percent. Engine speed was increased from 7200 rpm to 8300 rpm to produce the maximum power of 184 kW with the maximum torque increased to 218 Nm at 7500 rpm. Engine mechanical friction was considerably decreased by using lighter power cylinder components, a roller-follower for variable valve timing and lift electronic con-

Note: Name in bracket designates references at end of this report

trol (VTEC) valve train, and a cylinder block designed for reducing windage effect and pumping loss. At 7000 rpm, the mechanical friction decreased by 25 percent. Intake manifold and ports were modified to reduce the volume in order to increase the responsiveness of the engine by 18 percent in terms of engine speed rise rate without affecting the maximum power output.

While technology was developed for increasing the maximum power, emissions control technology was refined to meet future emissions standards. The catalyst's substrate was changed from ceramic to metal. Secondary air injection was employed to increase catalyst temperature rise rate when the engine is cold. A metal having 40 micrometer thickness (instead of 105 micrometer of ceramic) helped reduce the exhaust gas flow resistance by 42 percent. Thus, the metal substrate could reduce the exhaust back pressure without increasing cell density. The secondary air was supplied by an electric motor-driven pump to each exhaust port. Relatively rich mixture operation emitted unburned fuel into the exhaust. With the secondary air, the unburned fuel was combusted to generate heat so that the catalyst rapidly warmed up. As a result, the catalyst temperature increased 200°C higher than the engine without the secondary air supply. Under the Japan 10-15 mode emissions test conditions, all three gaseous emissions, carbon monoxide (CO), hydrocarbon (HC), and nitrogen oxides (NOx), met the target of half of Japan's emissions standards for the year 2000.

Nissan's RB20DE, a 1.998-liter, in-line six engine, powerplant of a sport sedan called "Skyline™," has been revised to consume less fuel and produce more power. Engineers at Nissan Motor Co., Ltd., Kanagawa, Japan [Nishizawa et al.], developed lean-burn technology for a short-stroke engine which has been known to be difficult compared to application in a long-stroke engine. Tumble air motion was effectively generated by the low-restriction intake system called the "Air Jet Swirler"

(AJS). The uniquely configured, concave piston crown retained turbulence intensity longer near top dead center (TDC). Both AJS and the concave piston crown successfully increased the burn rate of lean mixture in a short-stroke engine. In addition, engine friction was reduced by 20 percent at all engine speeds, and idle speed was set lower to gain fuel economy. The automatic transmission was redesigned as well to improve power transmission of the lean-burn engine. As a result, fuel economy improved by 14 percent under the Japan 10-15 mode operating conditions compared to the previous model.

Engine power output was increased by improving charging efficiency. Variable features were used for adjusting valve timing and lift and intake manifold volume depending on engine operating conditions. Intake port geometry was designed to achieve both high tumble motion and low flow coefficient. The peak torque increased to 186 Nm at 4400 rpm, and the maximum power increased to 114 kW at 6400 rpm compared to those of the previous model.

1.1 THE TWO-LITER, INLINE-FOUR DESIGNED FOR HONDA S2000 [Akimoto et al.]

A 2.0-liter, inline-four F20C engine was designed for Honda's sports car S2000. The engine was designed to achieve high vehicle performance, yet the exhaust emissions are sufficiently low to meet future emissions standards. The development targets are:

- Rated power output of 125 PS¹ (92 kWh) per liter
- Half the emissions standard planned for the year 2000 in Japan.
- Compact and lightweight design to fit in limited engine compartment space

¹ Metric horsepower

- High response suitable for sports car application.

F20C engine specifications are listed in Table 1.1.1. The specifications of the F20B engine designed for the 1998 Honda Accord™ are also listed for comparison. Figure 1.1.1 shows the overview of the F20C engine.

Considering the high-speed and high-power operation required for the F20C, the bore was 2 mm greater and the stroke was 4 mm shorter than those of the F20B designed for the Accord™. Reduced weight of moving components and the short stroke helped decreased engine vibration. Hence, no balance shaft was necessary. The cylinder block was made of a fiber-reinforced metal sleeve, aluminum die-cast, and a ladder frame was used to increase the structural rigidity.

The cylinder head was a compact design of three-piece construction. The valve's including-angle was 51 degrees. Variable valve timing and lift electronic control (VTEC) was modified by using a

roller-follower to reduce friction. The roller shaft consists of the VTEC's valve switching pin, as shown in Figure 1.1.2. The camshaft was operated by a silent chain instead of a conventional timing belt so that the engine length could be shorter. The intake

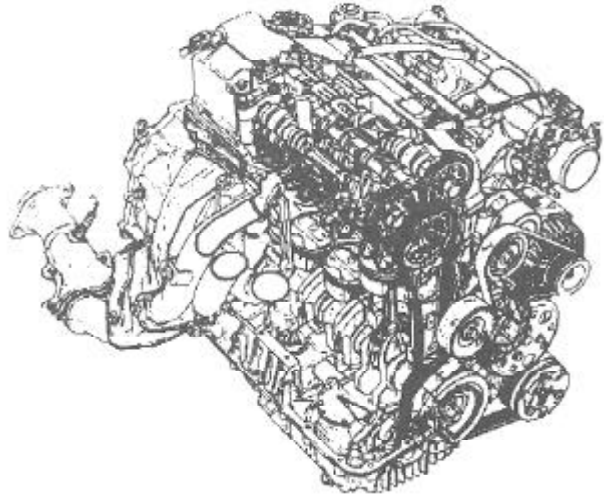

Figure 1.1.1
F20C ENGINE [Akimoto et al.]

Table 1.1.1
ENGINE SPECIFICATIONS [Akimoto et al.]

| Engine Type | F20C | F20B |
|-------------------------------------|------------------------------|------------|
| Cylinder Layout | L 4 | L 4 |
| Bore x Stroke (mm) | 87 x 84 | 85 x 88 |
| Displacement (cc) | 1997 | 1997 |
| Compression Ratio | 11.7 | 11.0 |
| Valve Train | DOHC VTEC Roller follower | DOHC VTEC |
| Camshaft Drive Train | Chain drive | Belt drive |
| Max. Power (kW/rpm) | 184 / 8300 | 147 / 7200 |
| Max. Torque (Nm/rpm) | 218 / 7500 | 196 / 6600 |
| BSFC (g/kWh) at 4.4 kW, 1500 rpm | 378 | 421 |

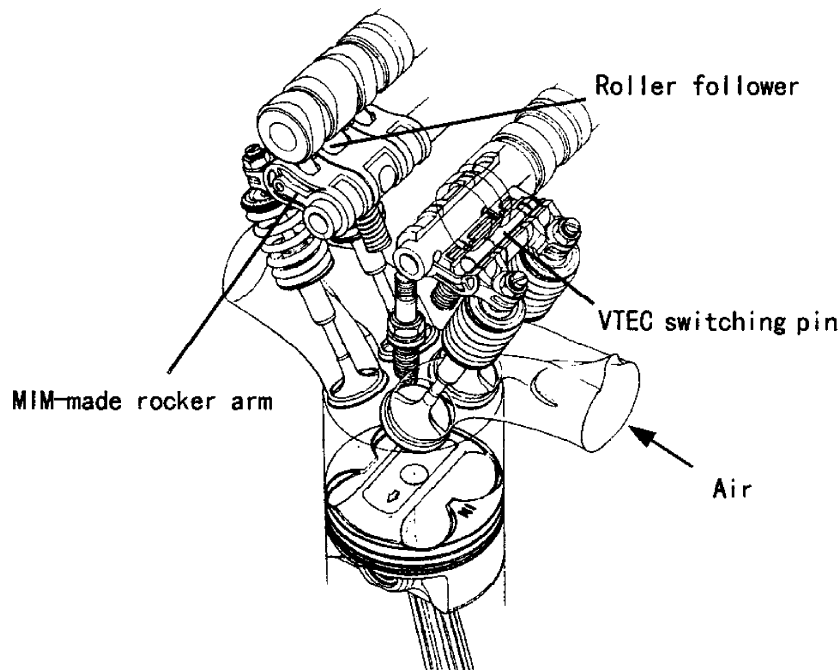

Figure 1.1.2
VALVE TRAIN [Akimoto et al.]

manifold volume was also reduced. The reduced flywheel weight improved engine response. The combination of various design improvements resulted in a 30-mm shorter engine that is about 8 kg lighter than the F20B. Table 1.1.2 lists design approaches and objectives.

The target power of 125 PS per liter was achieved by raising the engine speed to 8300 rpm. This power level falls in the category of naturally-aspirated racing engines, as shown in Figure 1.1.3. Intake and exhaust tuning and lower mechanical efficiency helped achieve high rated power without reducing torque in the low- and medium-speed range, as shown in Figure 1.1.4.

1.1.1 Technology Developed for F20C the Engine

Volumetric Efficiency Improvement:

The increased cylinder bore by 2 mm allowed both intake and exhaust valve diameters to be increased by 2 mm each. This

helped increase the effective flow area of each valve by 15 percent at the maximum valve lift. The intake system was designed to consist of an air cleaner integrated with a noise reduction device. The filter element of the air cleaner was a cone-shaped, axial flow which reduced flow restriction. The intake system design optimized for both low flow restriction and low noise achieved a flow increase of 20 percent compared to the F20B.

The exhaust system of the F20C was designed to meet future emissions standards and employed a metal substrate catalytic converter and secondary air injection. Thus, the exhaust pipe diameter upstream from the catalyst could be enlarged. The larger exhaust pipe diameter allowed the exhaust manifold design to be optimized for achieving a higher flow rate. Two of the exhaust pipes from four cylinders were first joined to make two outlets and then these two outlets were joined to connect the exhaust pipe. This 4-2-1 exhaust manifold

Table 1.1.2
DESIGN APPROACHES AND OBJECTIVES [Akimoto et al.]

| | Power | Emission | Small / Weight | Response |
|---------------------------------------|-------|----------|----------------|----------|
| New DOHC- VTEC cylinder-head | O | | O | |
| Roller VTEC | O | | O | O |
| MIM rocker-arm | O | | | |
| High strength valve spring | O | | | |
| Chain system | O | | O | |
| Forged piston | O | | | O |
| Carburized connecting rod | O | | | O |
| Ladder frame cylinder block | O | | O | |
| Straight port intake manifold | O | | O | O |
| Double-pipe exhaust manifold | O | O | | |
| Metal catalytic converter | O | O | | |
| Exhaust secondly air injection system | | O | | |
| Plug hole ignition coil | O | | O | |
| High response intake temp. sensor | | | | O |
| Serpentine belt drive system | O | | O | |

*MIM: Metal Injection Molding

configuration with the larger flow area and optimum length effectively increased the flow rate by 66 percent.

Designs for Increasing Mechanical Efficiency: In addition to friction reduction by using the short stroke, the cylinder block, which was designed to increase both the

length of an oil return passage and a breathing passage, decreased the windage effect at a high speed to reduce friction. The pumping loss that occurs between the cylinders in the crankcase was also reduced. The overall weight of the reciprocating components was reduced by about 10 percent

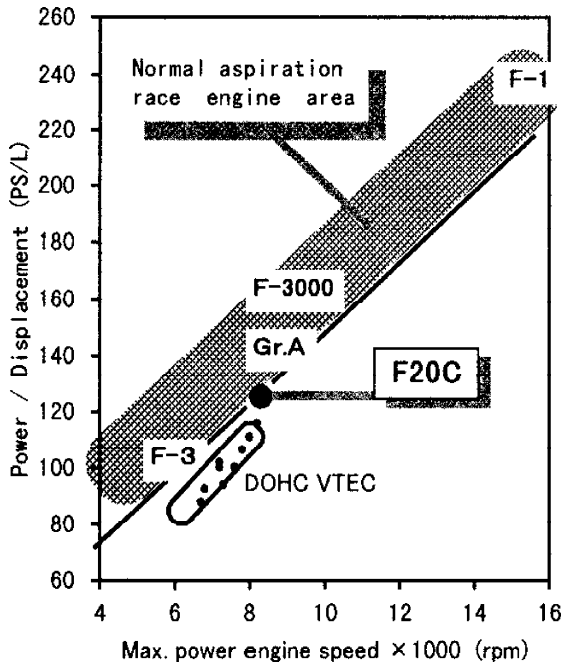

Figure 1.1.3
 SPECIFIC POWER (PS/L) AS A FUNCTION OF ENGINE SPEED [Akimoto et al.]

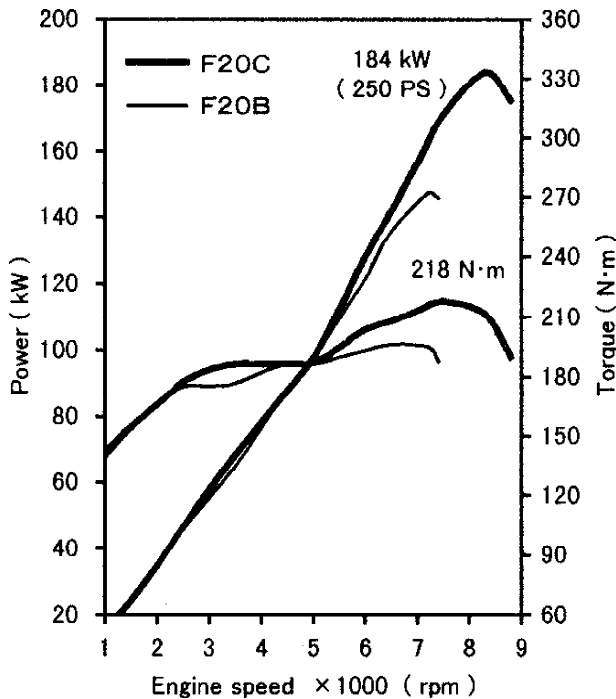

Figure 1.1.4
 POWER OUTPUT AND TORQUE AS A FUNCTION OF ENGINE SPEED [Akimoto et al.]

which contributed to the friction reduction. The piston was made of forged aluminum, and the connecting rod was made of carburized-cast iron. An integrated bracket layout used for mounting accessories reduced vibration so that no balancer would be needed. A roller-follower reduced valve train friction. As a result of the combined design features, the mechanical efficiency increased by 25 percent at 7000 rpm.

Technology to Increase Engine Speed:

High power was achieved by increasing engine speed from 7200 to 8300 rpm. Thus, the power cylinder component strength and reliability were of great concern. For example, the piston speed and piston acceleration reached the critical level, as shown in Figure 1.1.5.

Honda engineers conducted various tests and computer simulations to determine the most appropriate designs for the power cylinder components as follows:

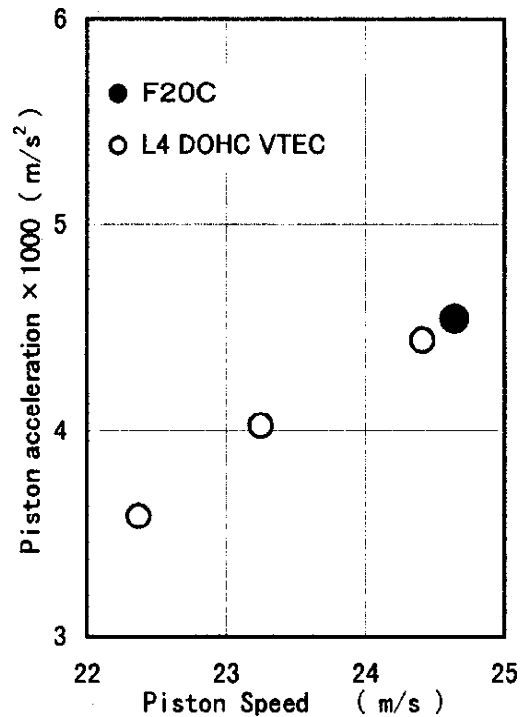

Figure 1.1.5
 THE RELATIONSHIP BETWEEN PISTON ACCELERATION AND PISTON SPEED [Akimoto et al.]

1. The piston was made of forged aluminum to increase fatigue strength and impact strength and decrease weight.
2. The piston pin was designed to reduce the internal diameter for reduced weight. The sliding surface was treated with iron oxides (Fe_3O_4), and the connecting rod short-end bushing was eliminated.
3. The connecting rod was made of carburized cast iron to increase fatigue strength at the small end and fretting strength at the big end.

In addition, the crankshaft was made of S48C with a supplement of manganese to increase torsional strength. The corner of the oil supply hole drilled in the crank pin was machined with a 20-degree chamfer to reduce the stress concentration.

Valve train components were also designed for high-speed application. A spring retainer was designed for optimum configuration with reduced weight. The valve spring material was modified by reducing the crystal particle size to increase the strength; a single spring was used for each valve which reduces the valve/spring assembly weight.

Ways to Achieve Fast Engine Response:

The variable-intake plenum chamber volume/length effectively uses the optimum pressure pulsation in the intake system to achieve high volumetric efficiency in a wide engine speed range. However, the effectiveness is obtained after the intake valves are closed in the case of the multi-cylinder engine, and there is time delay in achieving high volumetric efficiency. Therefore, the variable system is not appropriate for the sports car engine which requires fast engine response.

For the F20C engine, an approach was taken to reduce the volume downstream from the throttle valve, yet the maximum target power could be achieved. Intake port

diameter and length were reduced as much as possible. An independent straight port was used for each cylinder. This helped intake pressure to respond quickly to the movement of the throttle valve. As shown in Figure 1.1.6, the intake manifold volume could be reduced to the level of a 1.6-liter engine.

The compact intake manifold effectively increased the response of intake manifold pressure when the throttle was closed, as shown in Figure 1.1.7. The pressure decreased 100 msec faster than the F20B which had a variable intake system. Combining the compact intake volume with other factors such as a lighter flywheel, optimized fuel injection and ignition timing control, the engine speed response increased by 18 percent, as shown in Figure 1.1.8, when the throttle was fully opened from the closed position.

1.1.2 Exhaust Emissions Control

While technology was developed for increasing the maximum power, emissions control technology was refined to meet future emissions standards. The target was half of Japan's emissions standards for the

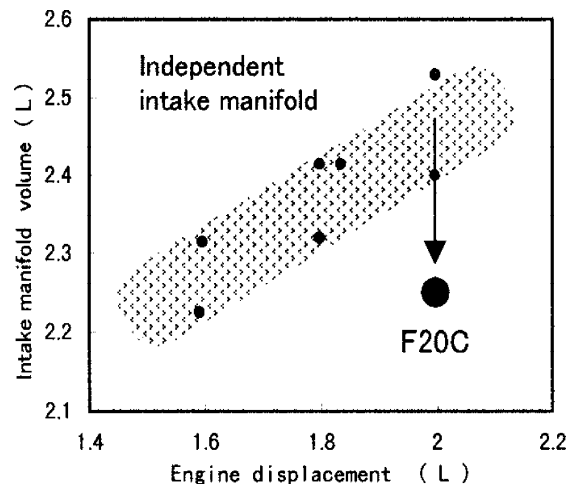

Figure 1.1.6
VOLUME OF INTAKE MANIFOLD DOWNSTREAM FROM
THE THROTTLE VALVE [Akimoto et al.]

year 2000. As shown in Figure 1.1.9, the catalyst's substrate was changed from ceramic to metal. The secondary air injection was employed to increase the catalyst temperature rise rate when the engine was cold.

Metal Honeycomb Catalyst: A thinner catalyst honeycomb structure effectively decreases exhaust gas flow resistance and thermal capacity. A metal with a 40 mi-

cro-meter thickness (instead of the 105-mi-crometer ceramic) reduced the exhaust gas flow resistance by 42 percent, as shown in Figure 1.1.10 and Figure 1.1.11. Thus, the metal substrate could reduce the exhaust back pressure without increasing cell density.

Multi-Port Secondary Air Injection System: To reduce cold-start emissions, the

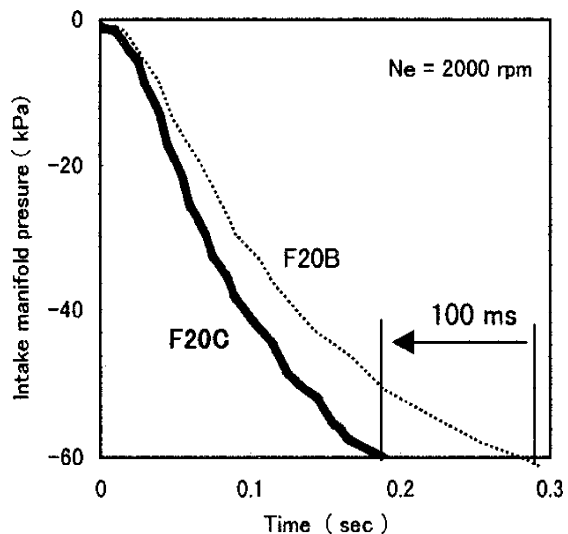

Figure 1.1.7
 INTAKE MANIFOLD PRESSURE RESPONSE TO
 THROTTLE CLOSURE [Akimoto et al.]

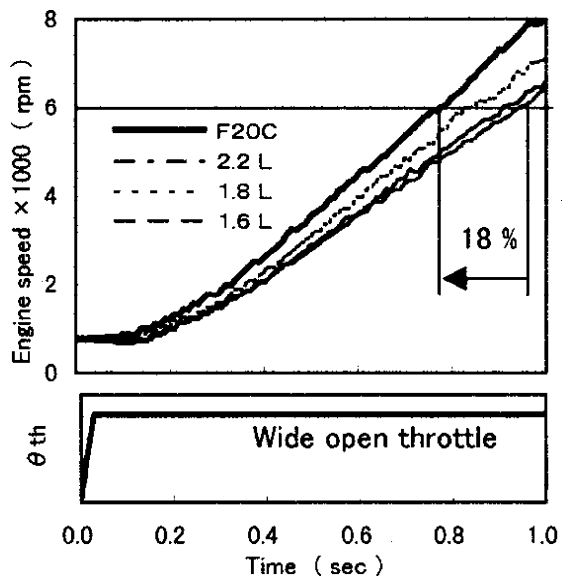

Figure 1.1.8
 ENGINE SPEED RESPONSE TO THROTTLE OPENING
 [Akimoto et al.]

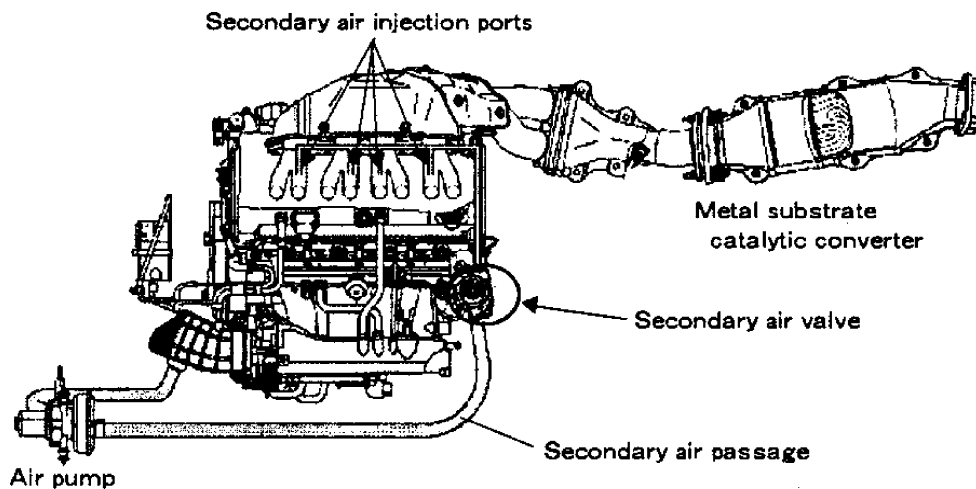

Figure 1.1.9
 AFTER-TREATMENT DEVICES [Akimoto et al.]

secondary air was supplied by an electric motor-driven pump to each exhaust port. Relatively rich mixture operation emitted unburned fuel into the exhaust. With the secondary air, the unburned fuel was combusted to generate heat so that the catalyst rapidly warmed up. As a result, the cata-

lyst temperature increased 200°C higher than the engine without the secondary air supply, as shown in Figure 1.1.12.

Spark-timing control was also developed to achieve low NOx and stable idle operation during the engine warm-up period. Figure 1.1.13 shows the emissions

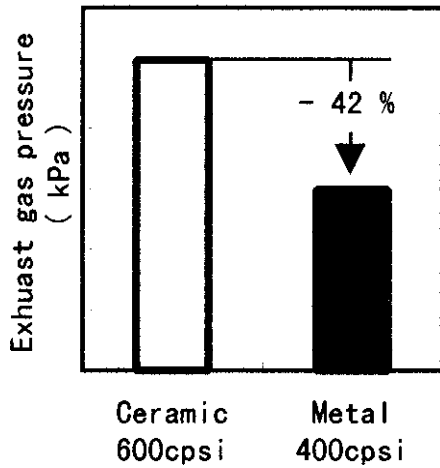

Figure 1.1.10
THE EFFECT OF A THIN METAL SUBSTRATE ON EXHAUST BACK PRESSURE [Akimoto et al.]

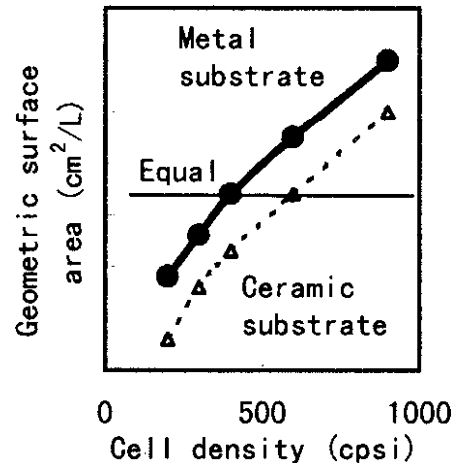

Figure 1.1.11
GEOMETRIC SURFACE AREA [Akimoto et al.]

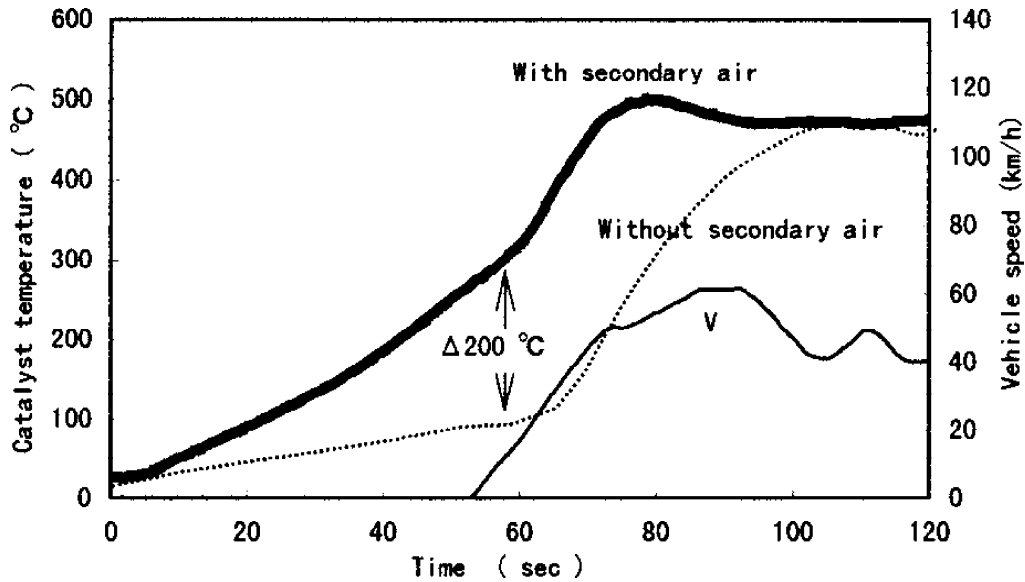

Figure 1.1.12
CATALYST TEMPERATURE AFTER THE ENGINE WAS STARTED UNDER JAPAN'S 11-MODE OPERATING CONDITION [Akimoto et al.]

measurement results obtained under Japan's 11-mode operating condition. CO, HC, and NOx decreased by 72, 55, and 64 percent compared to those of the F20B en-

gine. Table 1.1.3 lists the difference in emissions levels and emissions control methods between the F20C and F20B engines.

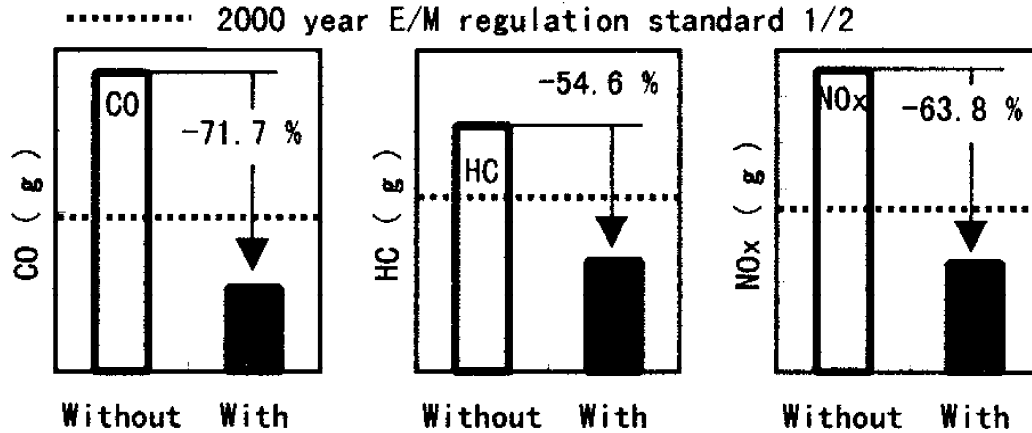

Figure 1.1.13

EMISSIONS MEASUREMENT RESULTS OBTAINED UNDER THE JAPAN 11-MODE [Akimoto et al.]

Table 1.1.3

EMISSIONS LEVEL AND EMISSIONS CONTROL METHODS [Akimoto et al.]

| Engine Type | | F20C | F20B |
|---------------------|---------|---|------------------------------------|
| Emission Target | | H. 12 1/2 | S. 53 |
| Emission 10-15 Mode | CO (g) | 0.30 | 0.80 |
| | HC (g) | 0.02 | 0.10 |
| | NOx (g) | 0.03 | 0.10 |
| Catalyst | | Metal 1.0 L 1.6 ml 400 cpsi | Ceramic 1.0 L 7.5 ml 400 cpsi |
| Emission System | | Electric pump exhaust secondary air injection | EGR |

1.2 A SHORT-STROKE, TWO-LITER, INLINE-SIX, LEAN-BURN ENGINE DESIGNED FOR NISSAN'S SPORT COUPE [Nishizawa et al.]

1.2.1 Lean-Burn Combustion Technology for a Short-Stroke Engine

Nissan's RB20DE engine was revised to improve fuel economy and increase output torque. Table 1.2.1 lists the engine specifications.

Table 1.2.1
ENGINE SPECIFICATIONS [Nishizawa et al.]

| | |
|----------------------------------|------------------------|
| Name | RB20DE (Lean-burn) |
| Displacement (cc) | 1998 |
| Arrangement and No. of Cylinders | In-line 6 cylinders |
| Bore x Stroke (mm) | 78.0 x 69.7 |
| Compression Ratio | 9.5 : 1 |
| Max. Power (kW/rpm) | 114 / 6400 |
| Max. Torque (Nm/rpm) | 186 / 4400 |
| Fuel | Premium (100 RON) |

A lean-burn combustion system was employed to reduce fuel consumption. To achieve efficient combustion, adequate air motion is necessary to complete combustion of lean mixture in a limited time. An engine with a longer stroke has an advantage in producing such air motion as that required for lean-burn operation, especially at a low engine speed. The RB20DE engine has a stroke (69.7 mm) shorter than the cylinder bore (78.0 mm). Thus, technology had to be developed to achieve efficient lean-burn operation in the short-stroke engine. Technical approaches employed for the technology development are:

1. An air jet swirler (AJS),
2. A concave piston crown, and
3. An extended discharge ignition coil.

Generally, the intake port of a lean-burn engine is designed to produce air motion in the cylinder to enhance lean combustion. This approach, however, increases flow restriction and defeats the purpose of lean-burn operation that reduces pumping loss. Also, the increased flow restriction needs to be avoided when the engine is developed for producing higher power output. Nissan engineers, therefore, set the following two objectives in their development:

- Efficient production of air motion in the cylinder and improvement of the mixture homogeneity and
- Improvement of turbulent flow stability and efficient generation of turbulence in order to increase combustion rate.

The air jet swirler (AJS), as shown in Figure 1.2.1, was developed to produce tumble flow in the cylinder. The intake manifold passage was modified to divide the single passage into two passages. Auxiliary passages were made above the main passage where a shutter valve was installed. By closing the shutter valve, intake air flows through the auxiliary passages and generates tumble air motion in the cylinder when the engine is operated on lean mixture.

The piston crown was configured to retain tumble motion in the cylinder when the piston was moved in the upstroke. A concave shape, shown in Figure 1.2.2, effectively achieved the objectives. Both the AJS and concave piston crown effectively improved lean combustion in the short-stroke engine and achieved stable lean combustion similar to that found in a long-stroke engine.

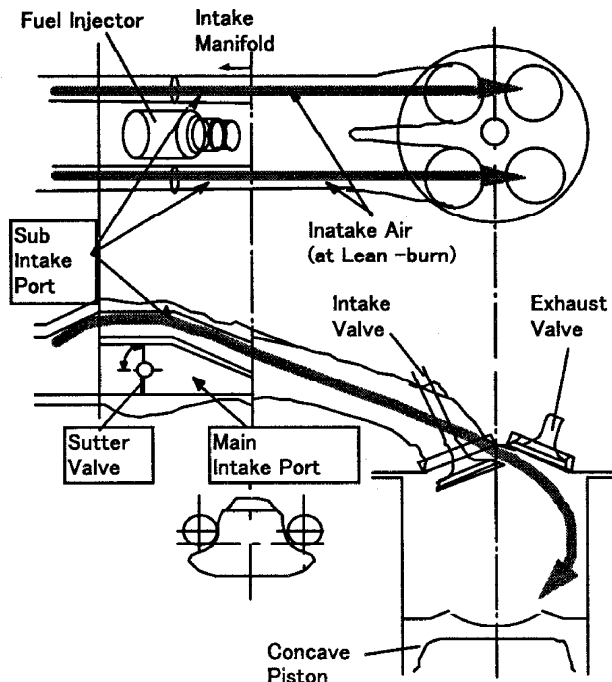

Figure 1.2.1
 AIR JET SWIRLER (AJS) [Nishizawa et al.]

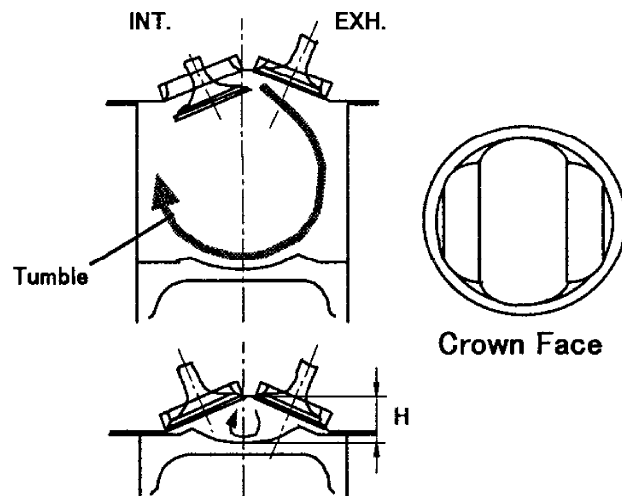

Figure 1.2.2
 CONCAVE PISTON CROWN [Nishizawa et al.]

Effects of Improved Lean-Mixture Homogeneity with AJS: It is important to produce homogeneous mixture in the combustion chamber of a lean-burn engine. Homo-

geneous mixture stabilizes lean combustion and produces lower NO_x emissions. By use of a laser-induced fluorescence (LIF) method, the mixture distribution was measured in the combustion chamber. The results were obtained for the effects of AJS and compared with those of a conventional swirl control valve (positioned to generate tumble) and those of no device for generation of air motion.

AJS can direct intake air flow to impinge on the backside of an intake valve. Fuel injected toward the intake valve is, therefore, well mixed with intake air before the fuel enters the cylinder. As shown in Figure 1.2.3, the LIF images showed significantly less liquid phase flow in the combustion chamber during the early intake stroke. Air motion generated by the swirl control valve was not able to direct flow intake air and impinge on the backside of the intake valve. Thus, fuel liquid adhered on the intake valve flows into the cylinder. This phenomenon was verified with the three-dimensional simulation results obtained for the part-load condition, as shown in Figure 1.2.4. Liquid fuel tends to enter the cylinder in the early intake stroke. Therefore, AJS could accelerate the mixing process in the early intake stroke and provide sufficient time for mixing fuel and air in the cylinder. Hence the mixture distribution improved, and homogeneous mixture could be produced in a short-stroke engine, as shown in Figure 1.2.5.

The piston speed of a long-stroke engine is higher than that of a short-stroke engine. Even though liquid fuel enters the cylinder in the early intake stroke, there is sufficient air motion to enhance the mixing and vaporization process. Especially at a lower engine speed, a short-stroke engine becomes a disadvantage for producing homogeneous mixture. Hence, early mixing of fuel during the intake stroke accomplished by AJS

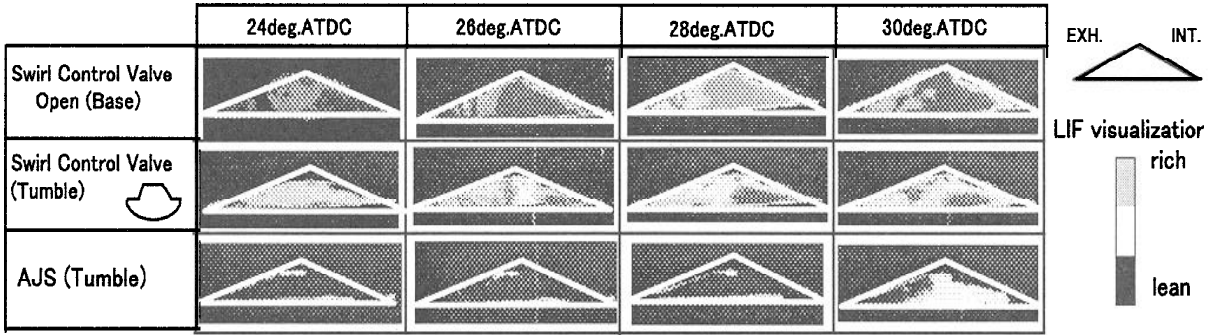

Figure 1.2.3
MIXTURE DISTRIBUTION IN EARLY INTAKE STROKE - 1200 RPM WITH SPARK TIMING AT 90°CA BTDC
[Nishizawa et al.]

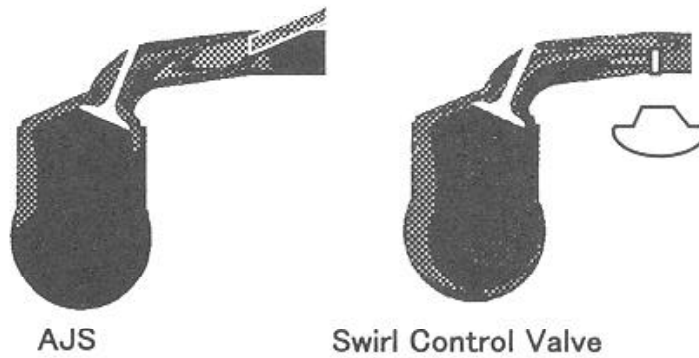

Figure 1.2.4
SIMULATION RESULTS [Nishizawa et al.]

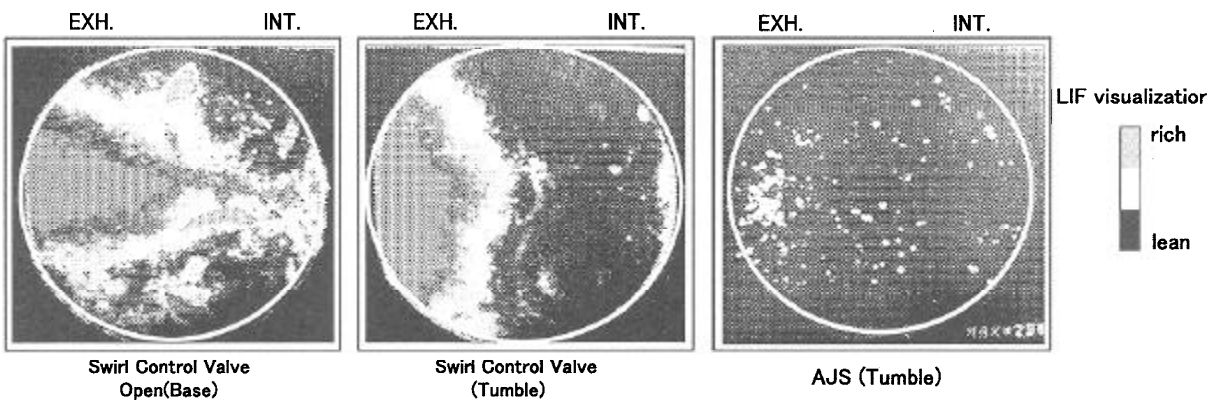

Figure 1.2.5
MIXTURE DISTRIBUTION IN LATER INTAKE STROKE - 1200 RPM WITH SPARK TIMING AT 90°CA BTDC
[Nishizawa et al.]

effectively stabilizes lean combustion and reduces NO_x.

Reliable Turbulence Generated by a Concave Piston Crown: AJS effectively produced air motion in the cylinder during the intake stroke and helped enhance fuel and air mixing to achieve high homogeneity. This air motion needs to be retained during the compression stroke, and a certain level of turbulence needs to be generated near TDC in order to increase the combustion rate. Nissan engineers configured the piston crown to maintain the air motion and organize tumble flow before micro-scale turbulence is generated near TDC. LIF images indicated that the concave piston crown retained tumble flow near TDC. A flat top piston tends to destroy tumble flow relatively early because of the relatively small clearance between the piston crown and the cylinder head fire deck (See "H" in Figure 1.2.2). Thus, the turbulence intensity tends to decay earlier, for example, at and after TDC.

A concave piston crown effectively increased the combustion rate, as shown in Figure 1.2.6. Even though a retarded spark timing was used for reducing NO_x, the crank angle duration of 10-90 percent mass

burn rate was short. Therefore, the concave piston crown improved the lean combustion in the short-stroke engine.

As a result, the lean-combustion became stable even though the air/fuel ratio was increased to 25. Under the Japan 10-15 mode, lean-burn operation improved fuel economy by 3.2 percent.

1.2.2 Overall Engine Performance

In addition to lean-burn operation, reduced mechanical friction contributed to fuel economy development. The following lists the improvements made for both reciprocating and rotating components and valve train components:

Reciprocating and Rotating Components:

- Two-ring pack piston (one compression ring and one oil control ring)
- Piston skirt profile optimization and molybdenum coating
- Micro-finish crankshaft journal

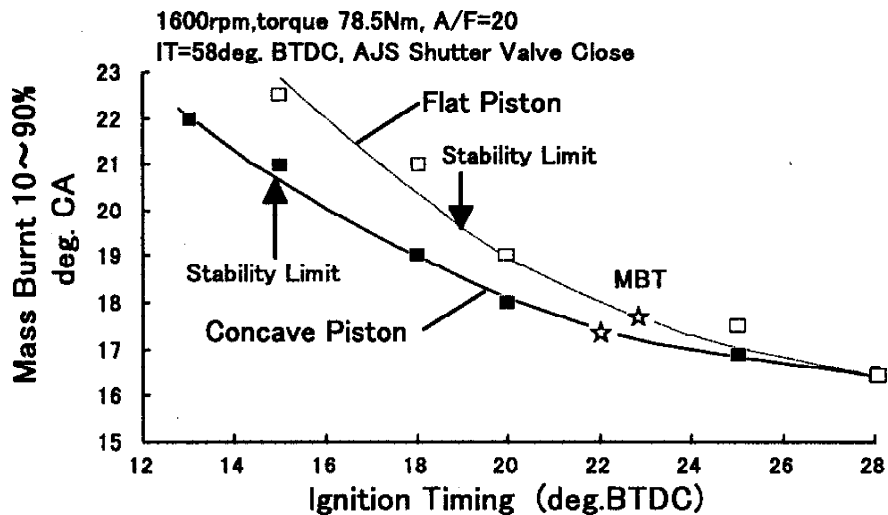

Figure 1.2.6

THE EFFECT OF A CONCAVE PISTON CROWN ON 10-90 PERCENT MASS BURN DURATION AS A FUNCTION OF SPARK TIMING [Nishizawa et al.]

- Smaller crankshaft journal diameter

Valve Train Components:

- Micro-finish camshaft
- No hydraulic tappet

In addition, oil pump gear geometry was modified to increase efficiency. The thermostat opening temperature was raised. Low-friction engine oil replaced the conventional engine oil. As a result, friction torque measured under motoring conditions decreased by about 20 percent at all engine speeds, as shown in Figure 1.2.7.

Idle speed was reduced to 550 rpm for the engine with an automatic transmission. Frequency of fuel cut during vehicle deceleration was increased. The RB20DE engine with the improved automatic transmission reduced fuel consumption 14 percent under the Japan 10-15 mode.

Peak engine torque increased by 4 Nm, and the maximum power increased by 10 kW as shown in Figure 1.2.8. These improvements were achieved by the following:

- High-response, wide range valve timing control system (NVCS)
- Variable induction system (NICS)
- Optimized intake port configuration
- Modified intake manifold diameter and length
- Optimized valve timing and increased valve lift
- A longer dual front inlet tube

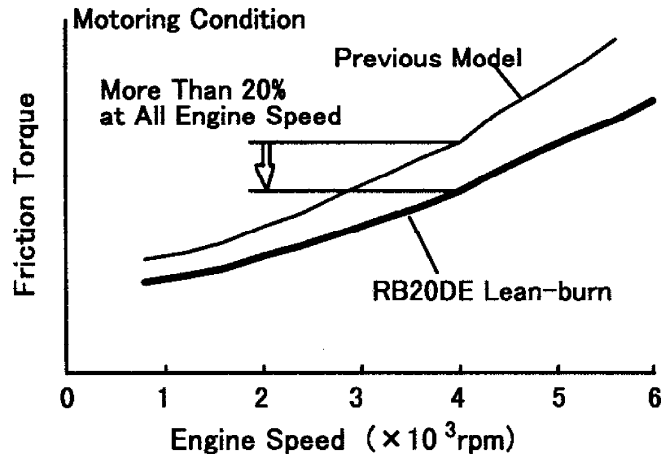

Figure 1.2.7
ENGINE FRICTION TORQUE MEASURED UNDER MOTORING CONDITIONS [Nishizawa et al.]

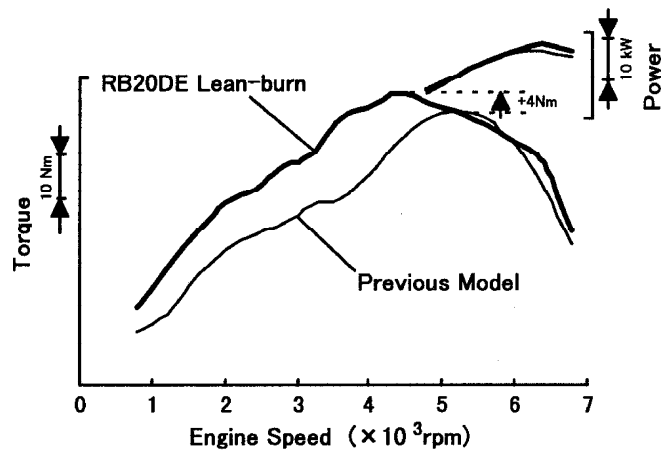

Figure 1.2.8
ENGINE TORQUE IMPROVEMENT [Nishizawa et al.]